

UWAGA! Przed przystąpieniem do montażu należy odłączyć zasilanie.

Instrukcja ustawiania mocy i połączenia zasilacza:

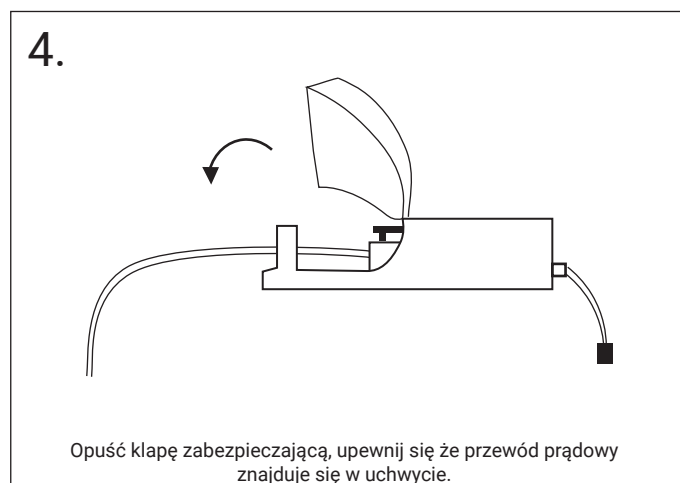
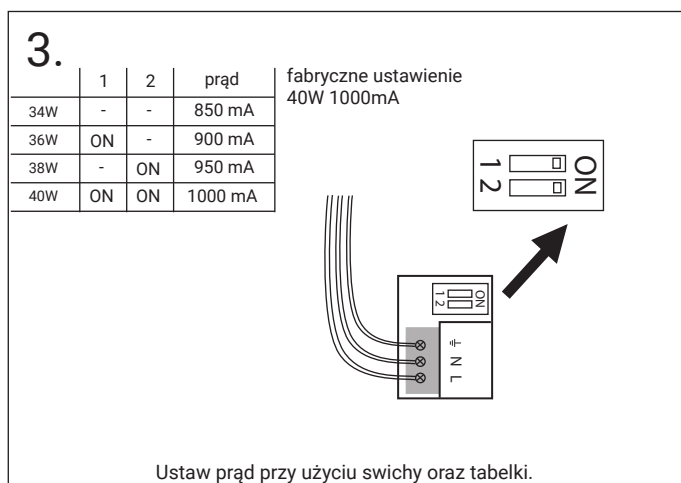
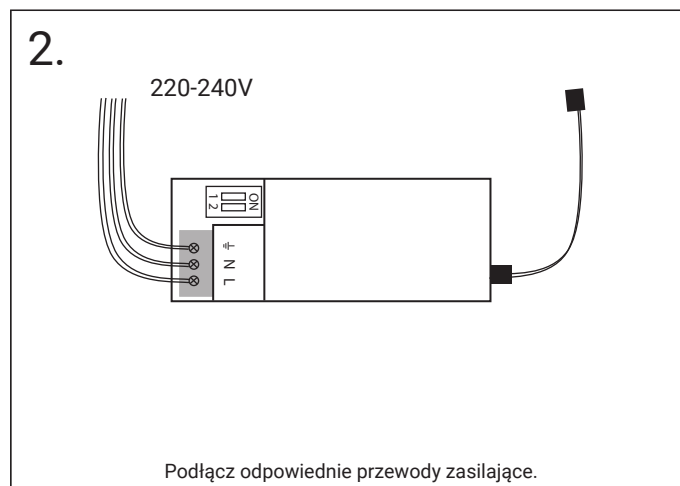
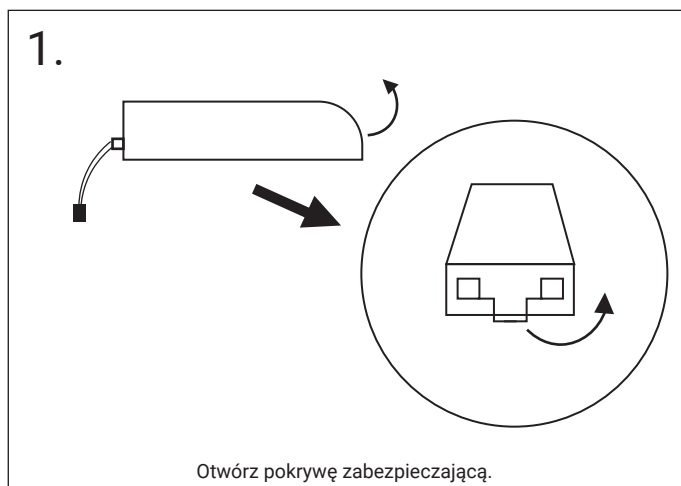

UWAGA! Przed przystąpieniem do montażu należy odłączyć zasilanie.

Instrukcja montażu w suficie rastrowym:

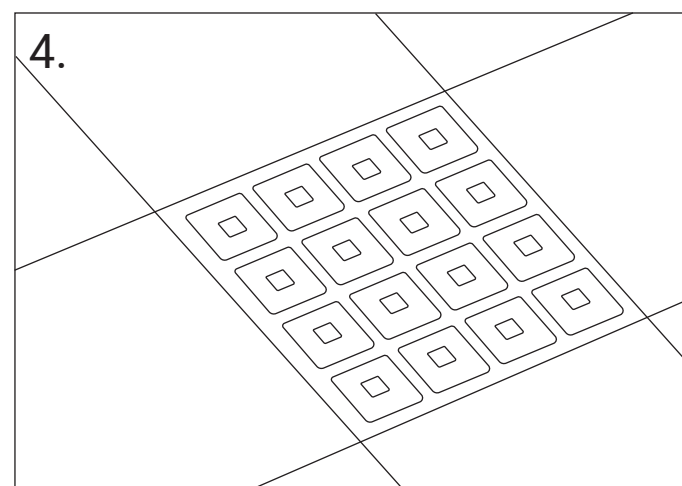
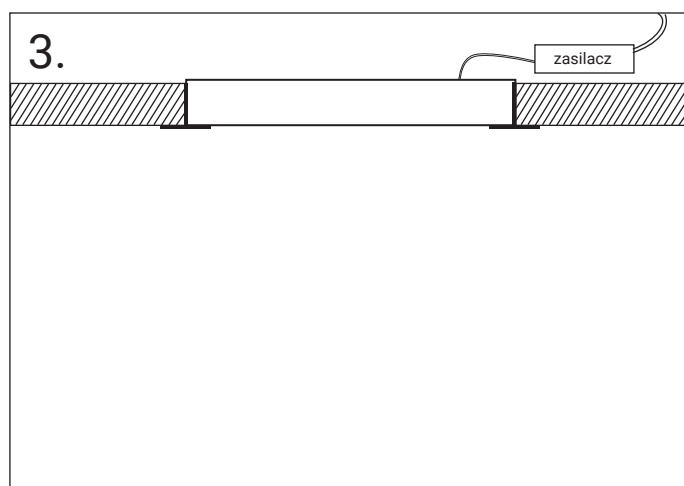
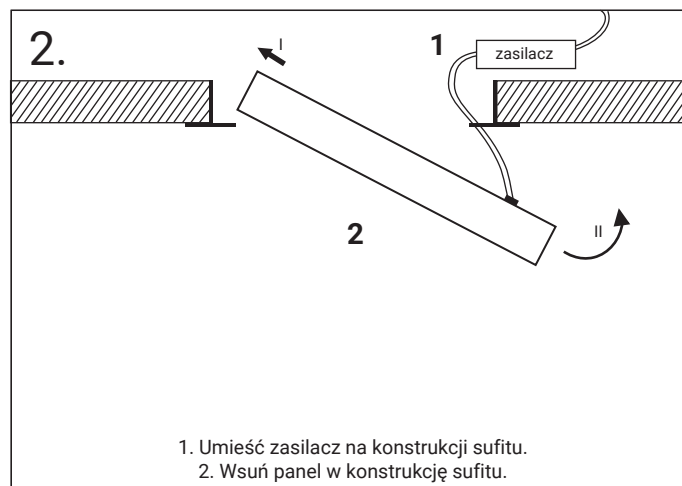
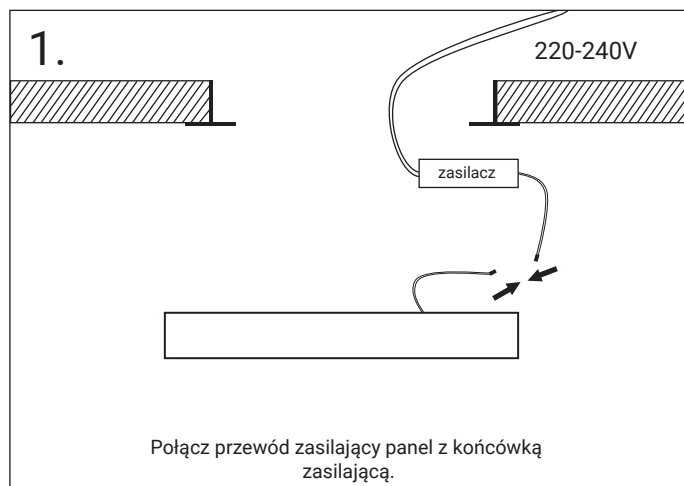

UWAGA! Przed przystąpieniem do montażu należy odłączyć zasilanie.

Instrukcja montażu natynkowego:

