

**UWAGA!** Przed przystąpieniem do montażu należy odłączyć zasilanie.

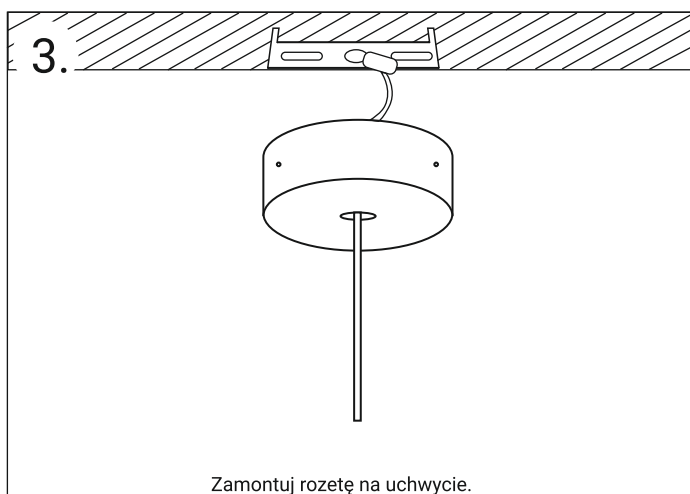

4.

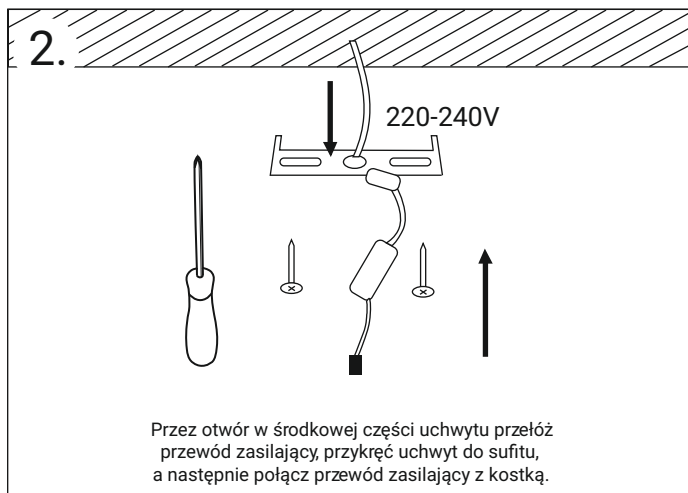
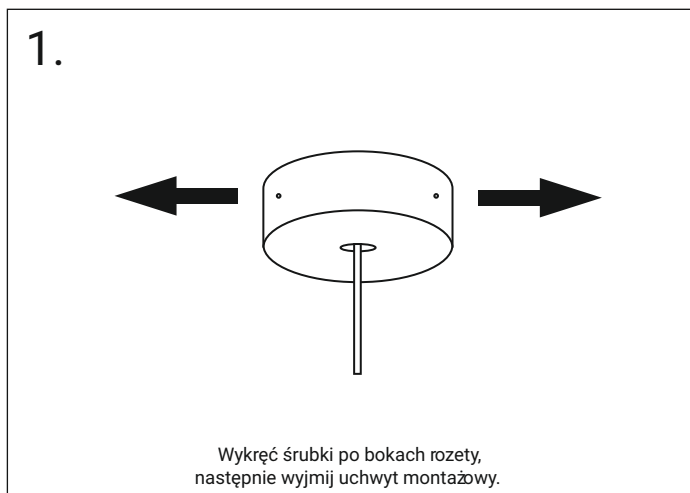