

UWAGA! Przed przystąpieniem do montażu należy odłączyć zasilanie.

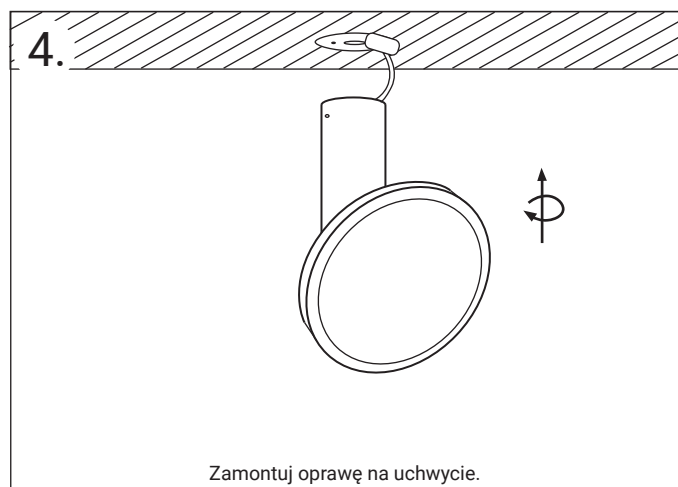

5.

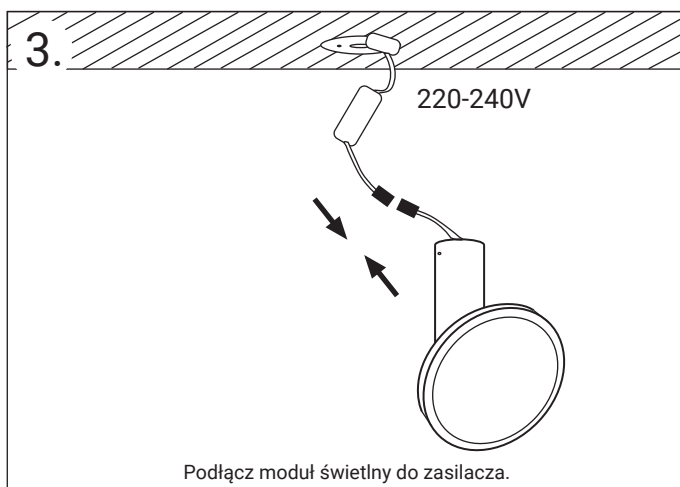
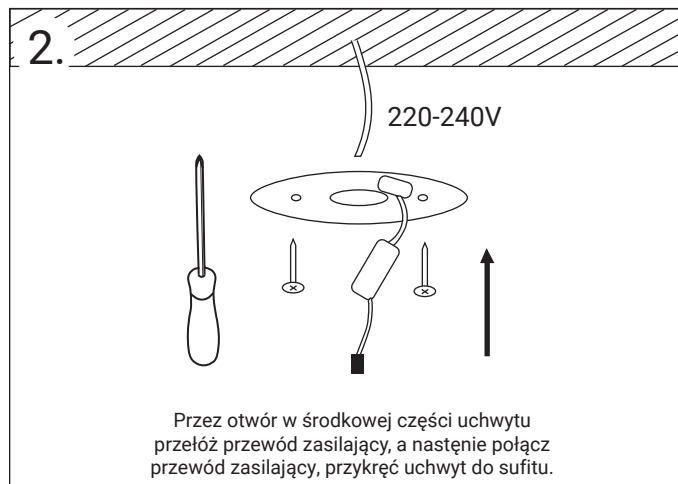
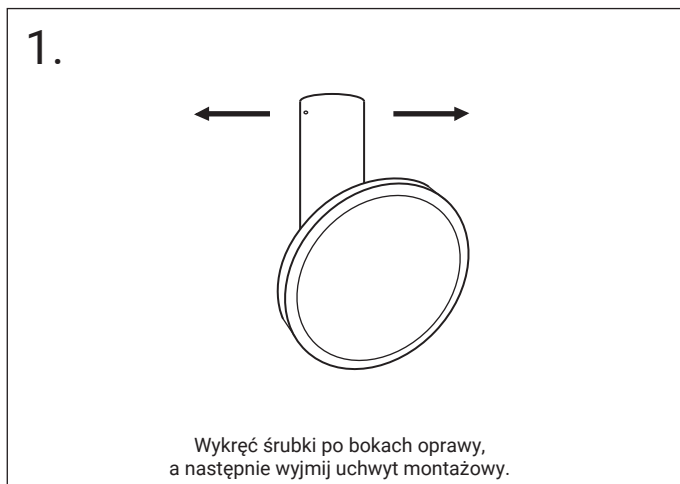